

zusätzliche Optionen

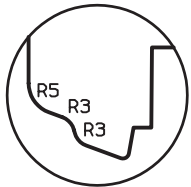

Rustikal Profil
am Flügel

zusätzliche Optionen

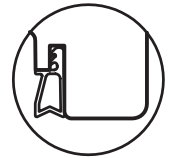

mittlere
Überschlagdichtung

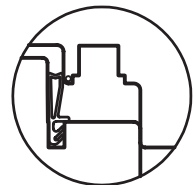

Rahmendichtung (20
mm) bei 12 mm
Falzlufte

- ☒
- * = 0.5 mm
- = 0.5x45°
- X = 1 x45°
- = 1.5x45°
- ▽ = 2 x45°
- = R 0.5
- ⊗ = R 1
- = R 1.5
- r = R 2
- R = R 2.5

Ers. durch:	Ers. für:	Maßstab	Gez.	05.11.09	DI
			1:1		
Änderungen:			Gepr.		
			%		
K-Name: ALBRECHT					
K-Nr.:					
IV FENSTER 78			4 09 262 020 A		
REGENSCHIEBE: SPREE					
ECKVERBINDUNG GEKONTERT					



CAD

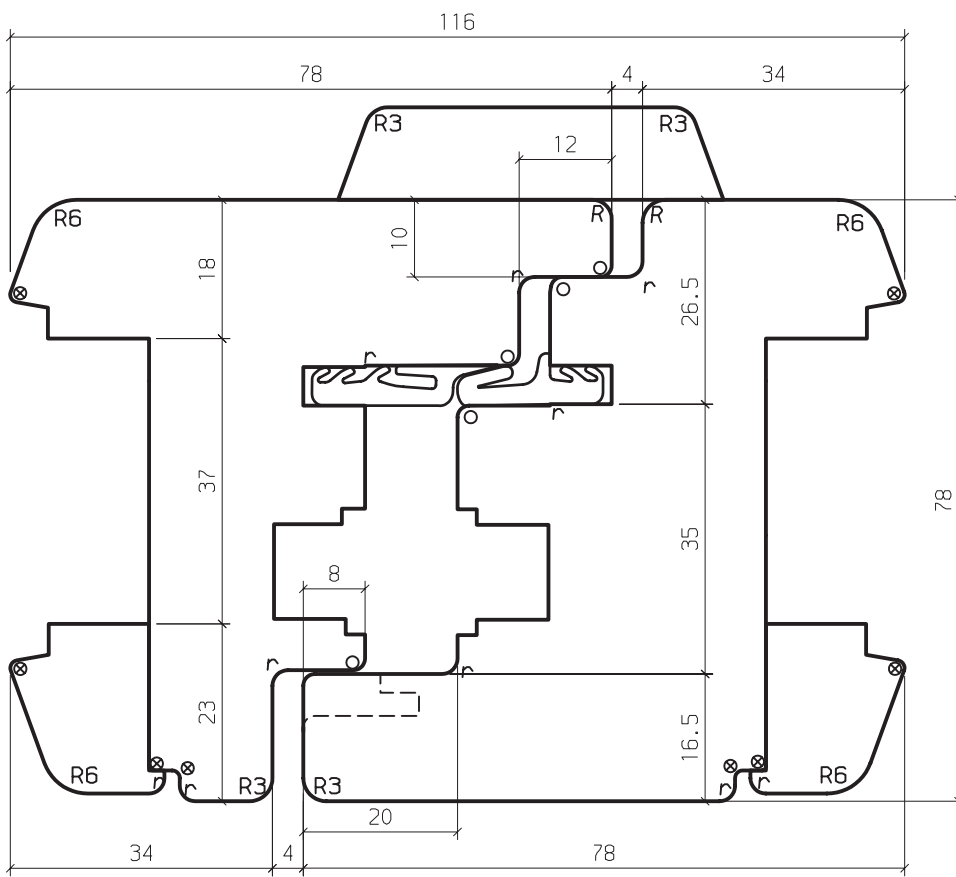

zusätzliche Optionen

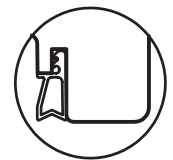

mittlere
Überschlagdichtung

CAD

Maßstab	Gez.	05.11.09	DI
	1:1		
K-Nr.	Gepr.		
	✓		
K-Name: ALBRECHT			
K-Nr.: . . .			
Ers. durch:	(B)	(D)	(F)
Aenderungen:	(C)	(E)	(G)
			
IV FENSTER 78 MITTELPARTIE INTEGRIERTE SCHLAGLEISTE			
4 09 262 021			A

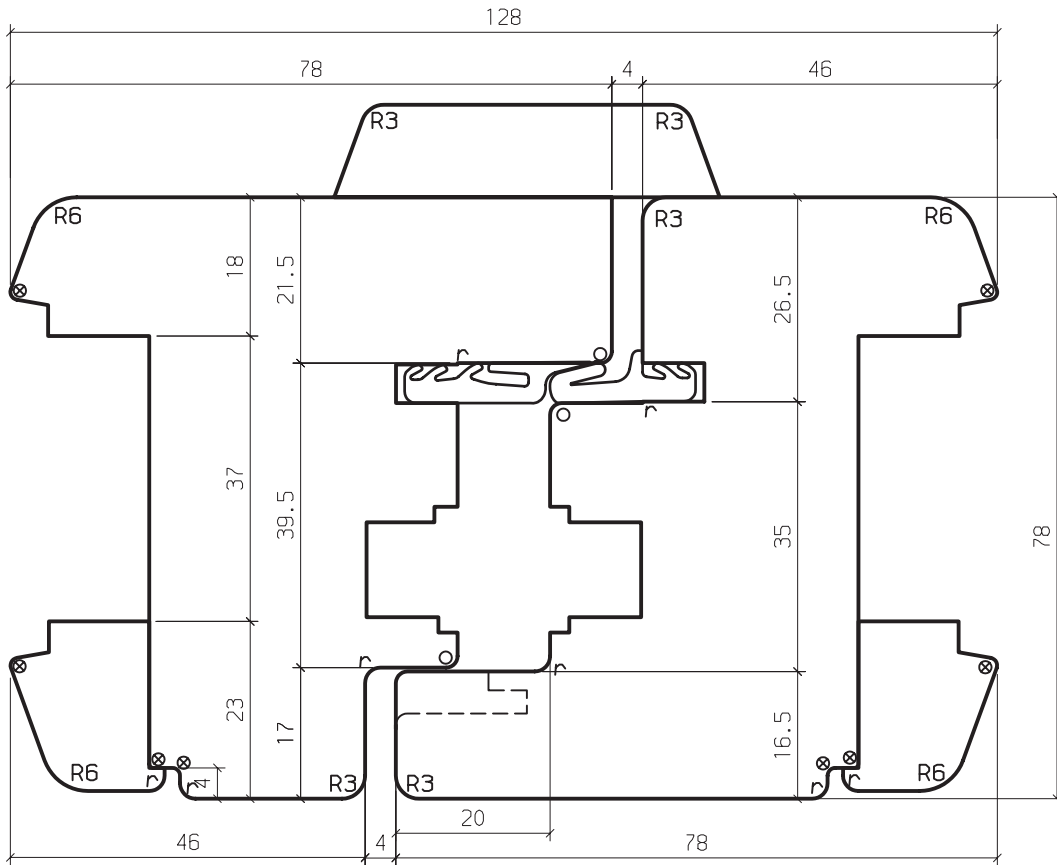

zusätzliche Optionen



mittlere
Überschlagdichtung

Maßstab	Gez.	05.11.09	DI
	1:1		
	Gepr.		
	%		
K-Name: ALBRECHT			
K-Nr.: . . .			
Ers. durch:	Ers. für:	(A)	(F)
(B)	(D)	(E)	(G)
Änderungen:			
(C)	(E)	(G)	
IV FENSTER 78 MITTELPARTIE AUFGESETZTE SCHLAGLEISTE			
CAD			
4 09 262 022			A

zusätzliche Optionen

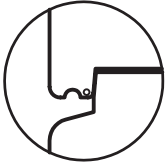

Offene Kopplung

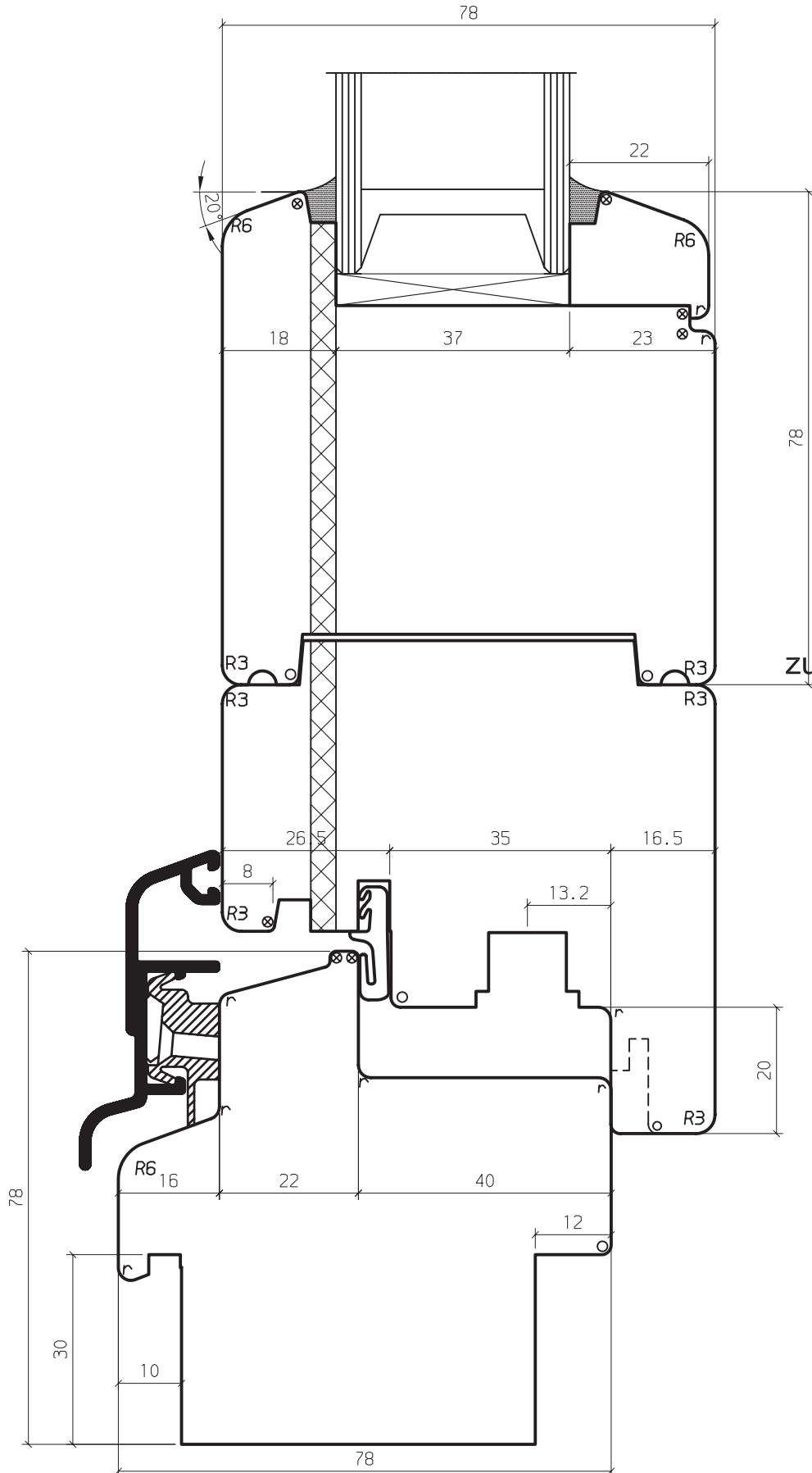

zusätzliche Optionen

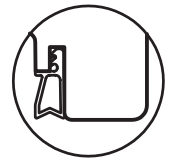

mittlere
Überschlagdichtung

Maßstab	Gez.	05.11.09	DI
	1:1		
	Gepr.		
	%		
K-Name: ALBRECHT			
K-Nr.: . . .			
IV FENSTER 78 REGENSCHIENE: SPREE FLÜGELAUFDOPPLUNG			
4 09 262 023 A			



CAD

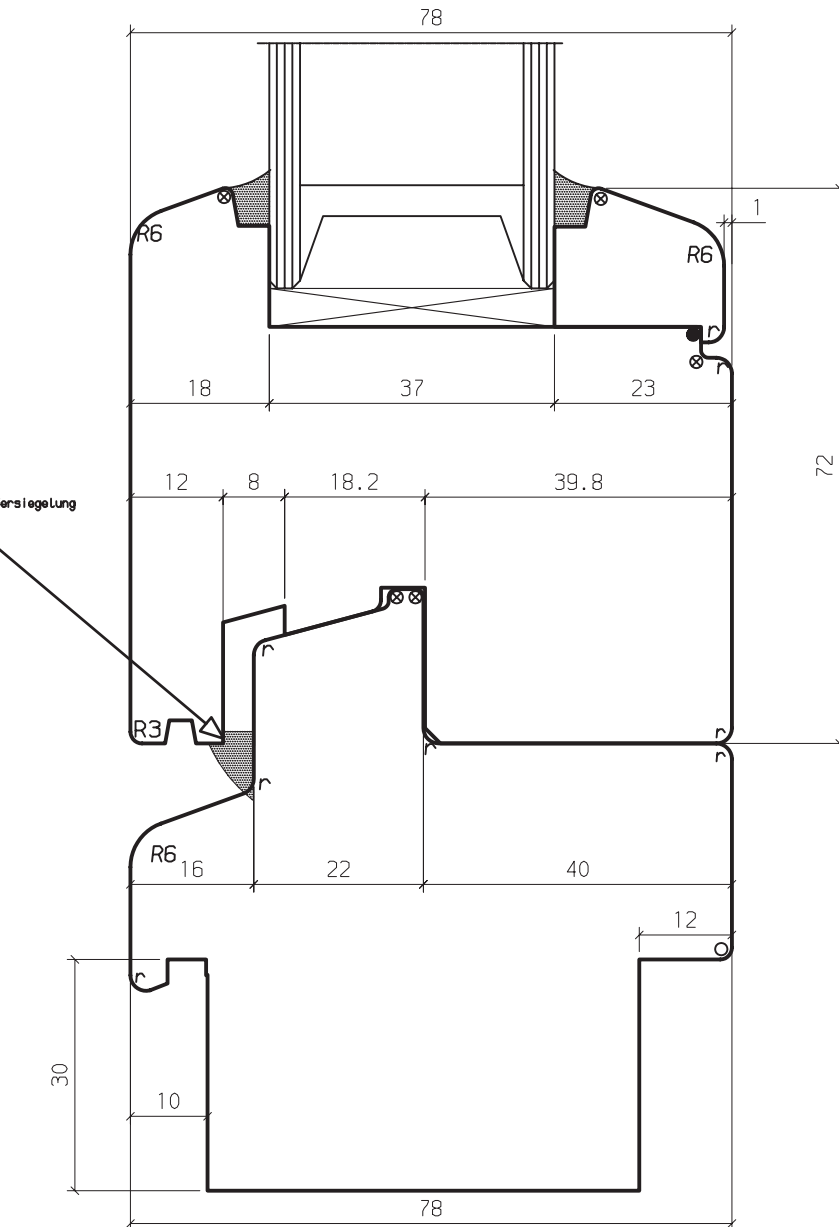
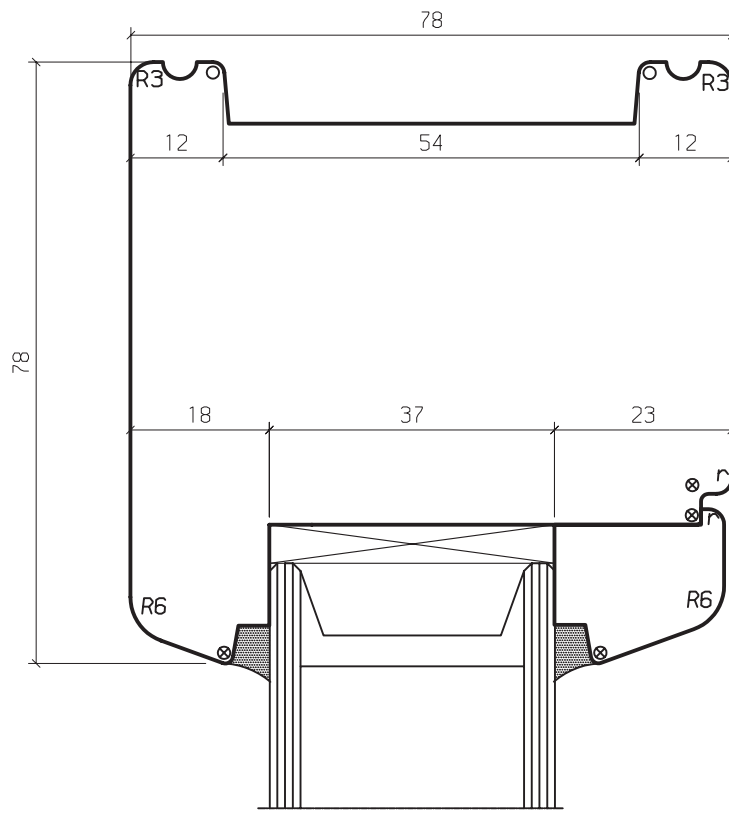

An den Ecken ohne Versiegelung

Ers. durch:	Ers. für:	Gez.	05.11.09	DI
(B)	(D)	(F)		
(C)	(E)	(G)		
K-Name: ALBRECHT				
K-Nr.: . . .				
				
IV FENSTER 78 FESTVERGLASUNG ECKVERBINDUNG: GEKONTERT				
CAD				
4 09 262 024 A				

CAD

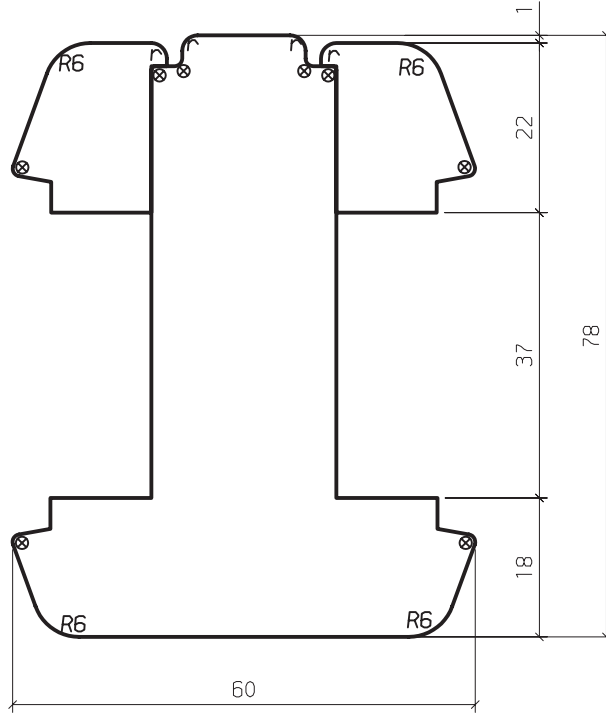
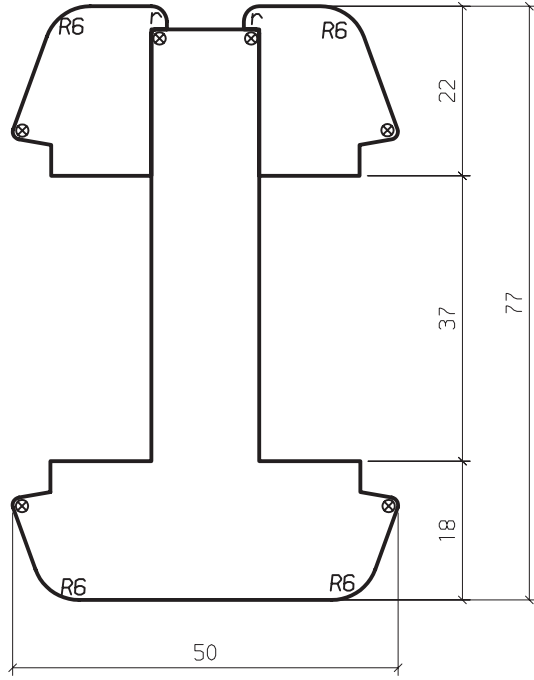

Ers. durch:	Ers. für:	Maßstab	Gez.	05.11.09	DI
			1:1		
Änderungen:	(D)	(E)	Gepr.	.	.
			(C)	(F)	(G)
			K-Name: ALBRECHT		
IV FENSTER 78 GLASTEILENDE SPROSSEN			K-Nr.: . . .		
			4 09 262 025 A		

CAD

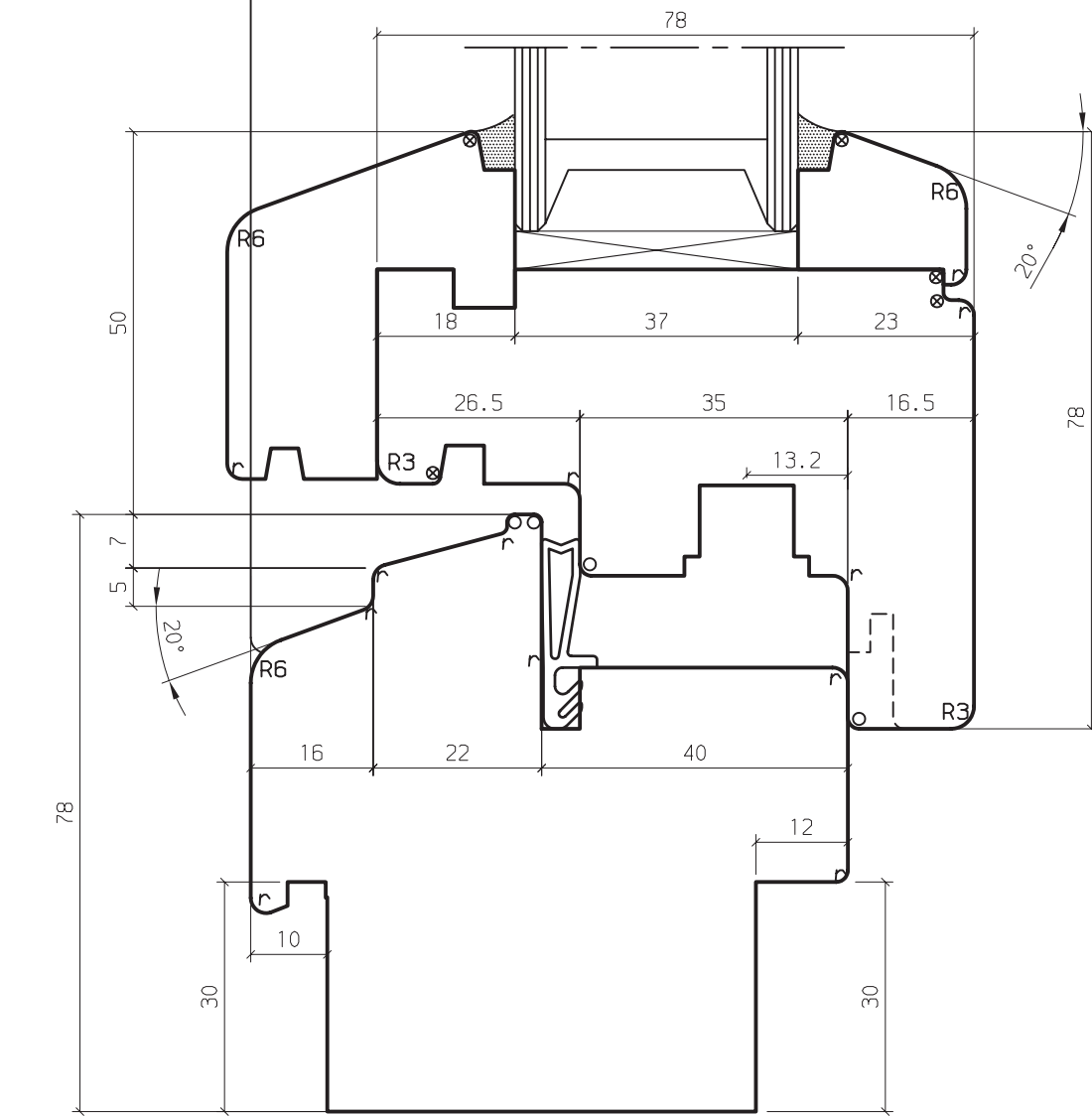
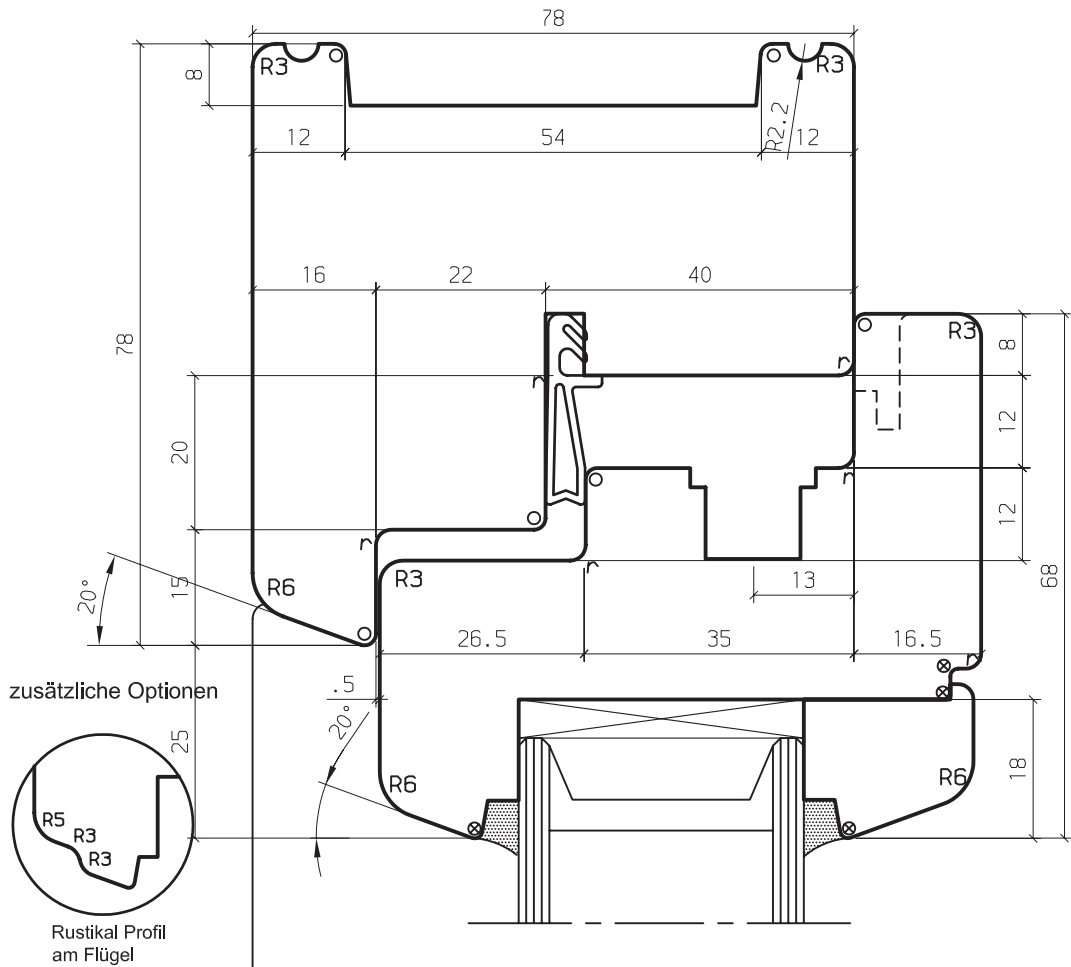

Maßstab	Gez.	05.11.09	DI
	1:1		
K-Nr.	Gepr.		
	1:1		
K-Name: ALBRECHT			
K-Nr.: . . .			
IV FENSTER 78 EINGEHÄNGTER WETTERSCHENKEL			
©ERTLI			
CAD			
4 09 262 026 A			

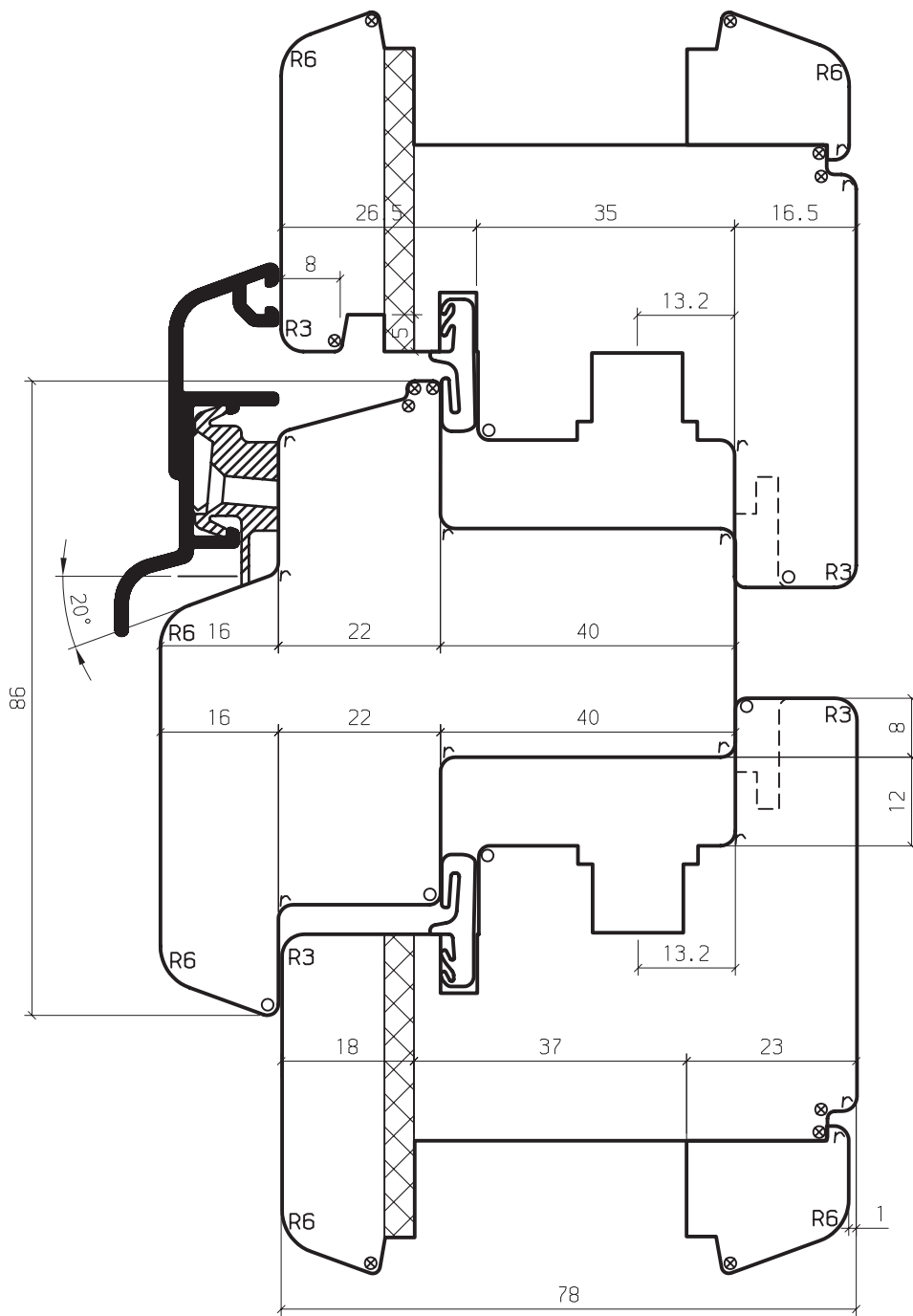

Maßstab	Gez.	05.11.09	DI
	1:1		
	Gepr.		
	✓		
K-Name: ALBRECHT			
K-Nr.: . . .			
IV FENSTER 78 KÄMPFER REGENSCHIEBE: SPREE			
Ers. durch:	(B)	Ers. für:	(A)
Aenderungen:	(C)	(D)	(F)
		(E)	(G)



zusätzliche Optionen



mittlere
Überschlagdichtung

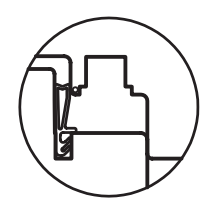

Rahmendichtung (20 mm) bei 12 mm Falzluft

CAD

4 09 262 027 A

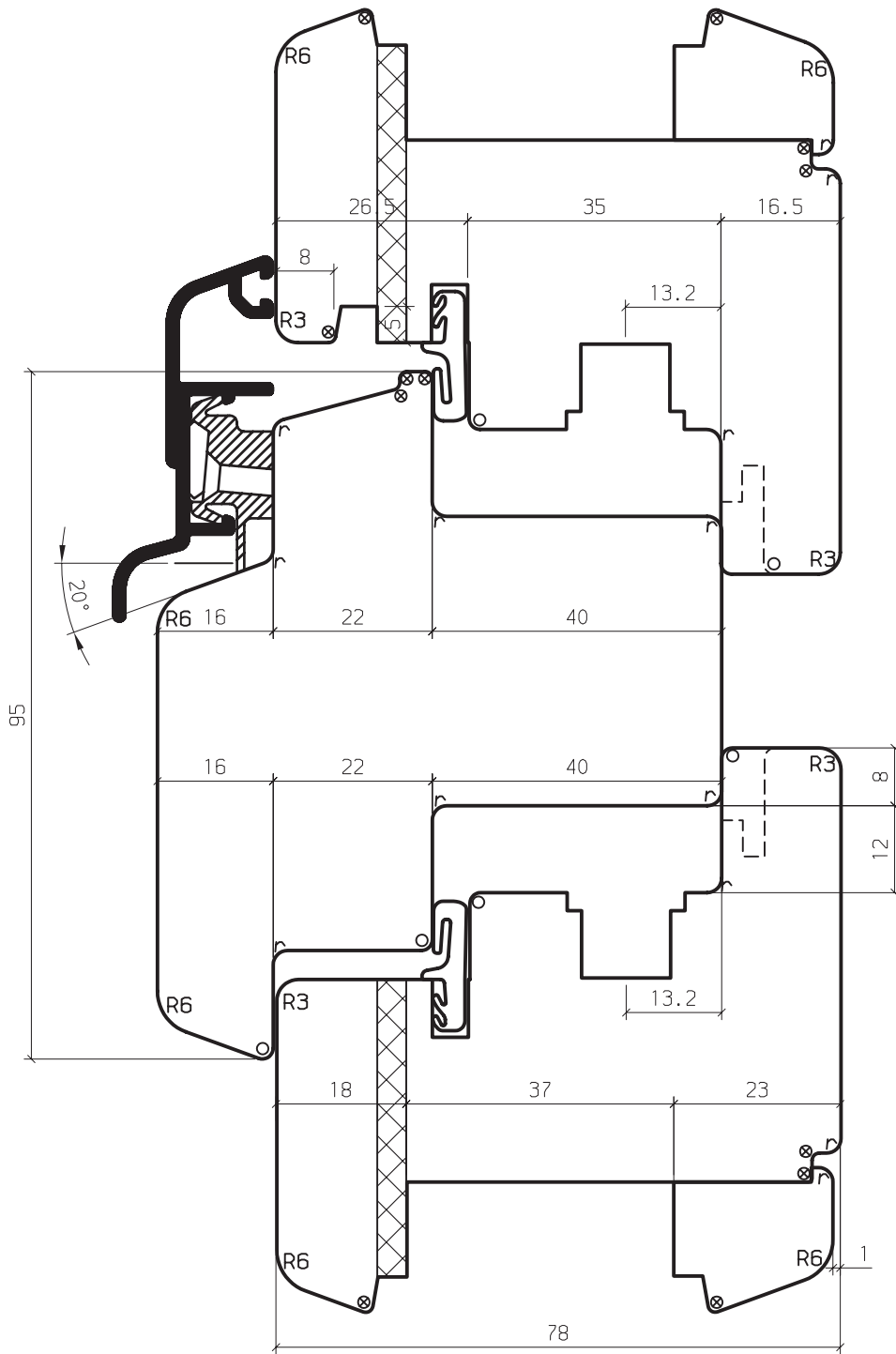

Maßstab	Gez.	05.11.09	DI
	1:1		
	Gepr.		
	%		
K-Name: ALBRECHT			
K-Nr.: . . .			
IV FENSTER 78 KÄMPFER REGENSCHIENE: SPREE			
			

zusätzliche Optionen

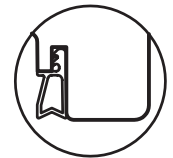

mittlere
Überschlagdichtung

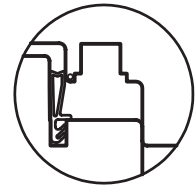

Rahmendichtung (20
mm) bei 12 mm
Falzluf

CAD

4 09 262 028 A

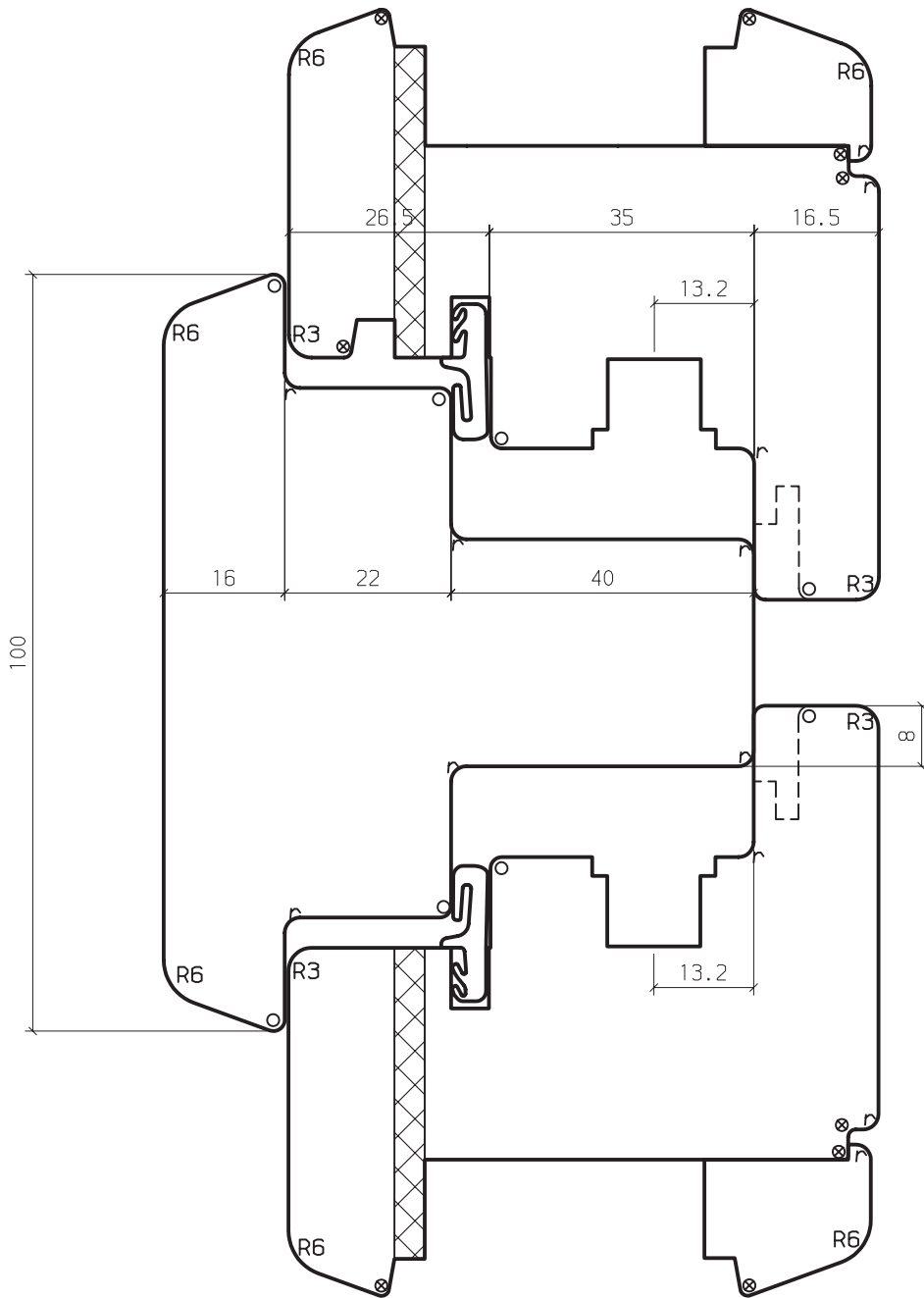

zusätzliche Optionen



mittlere
Überschlagdichtung

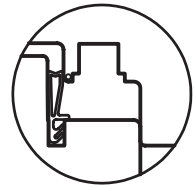

Rahmendichtung (20
mm) bei 12 mm
Falzlufte

Ers. durch:	Ers. für:	Maßstab	Gez.	05.11.09	DI
		(B)	(D)	(F)	(G)
Aenderungen:		1:1	Gepr.	.	.
(C)		∅			
K-Name: ALBRECHT					
K-Nr.: . . .					
IV FENSTER 78 SETZHOLZ 2-FLG DK-DK					
4 09 262 029 A					

CAD

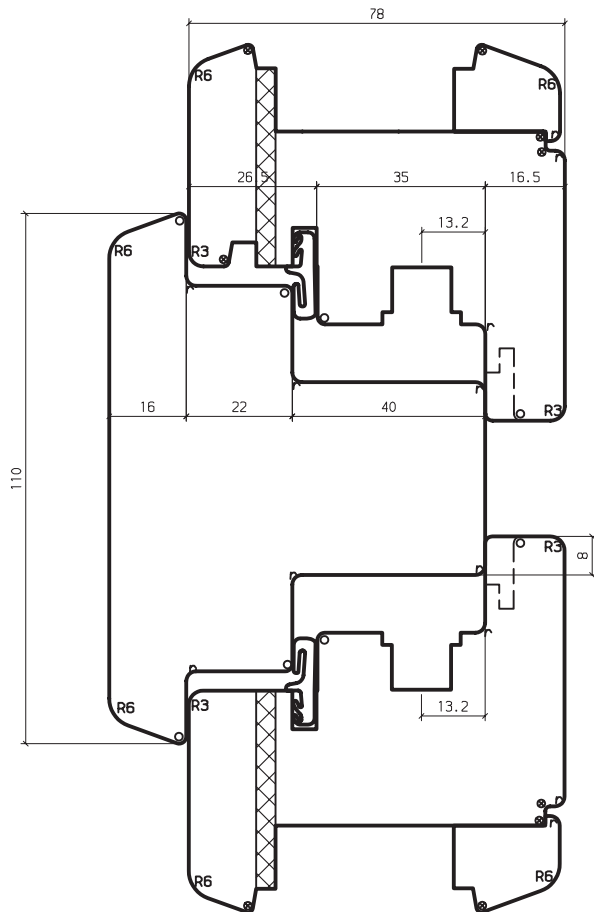
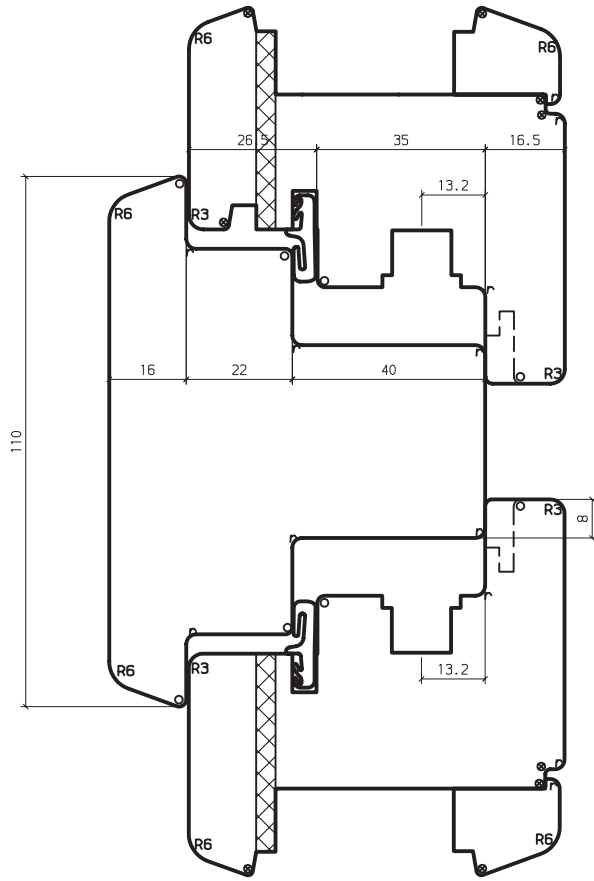

zusätzliche Optionen

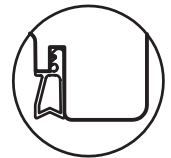

mittlere
Überschlagdichtung

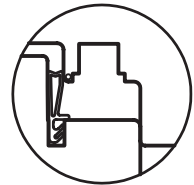

Rahmendichtung (20
mm) bei 12 mm
Falzlufte

Ers. durch:	(B)	Ers. für:	(A)	Maßstab	Gez.	05.11.09	DI
	(C)		(D)		(F)	1:1	Gepr.
Aenderungen:	(E)	(E)	(G)		∅		
 IV FENSTER 78 SETZHOLZ 3 FLG DK-DK-DK				K-Name: ALBRECHT K-Nr.: . . .			
				4 09 262 030 A			

CAD

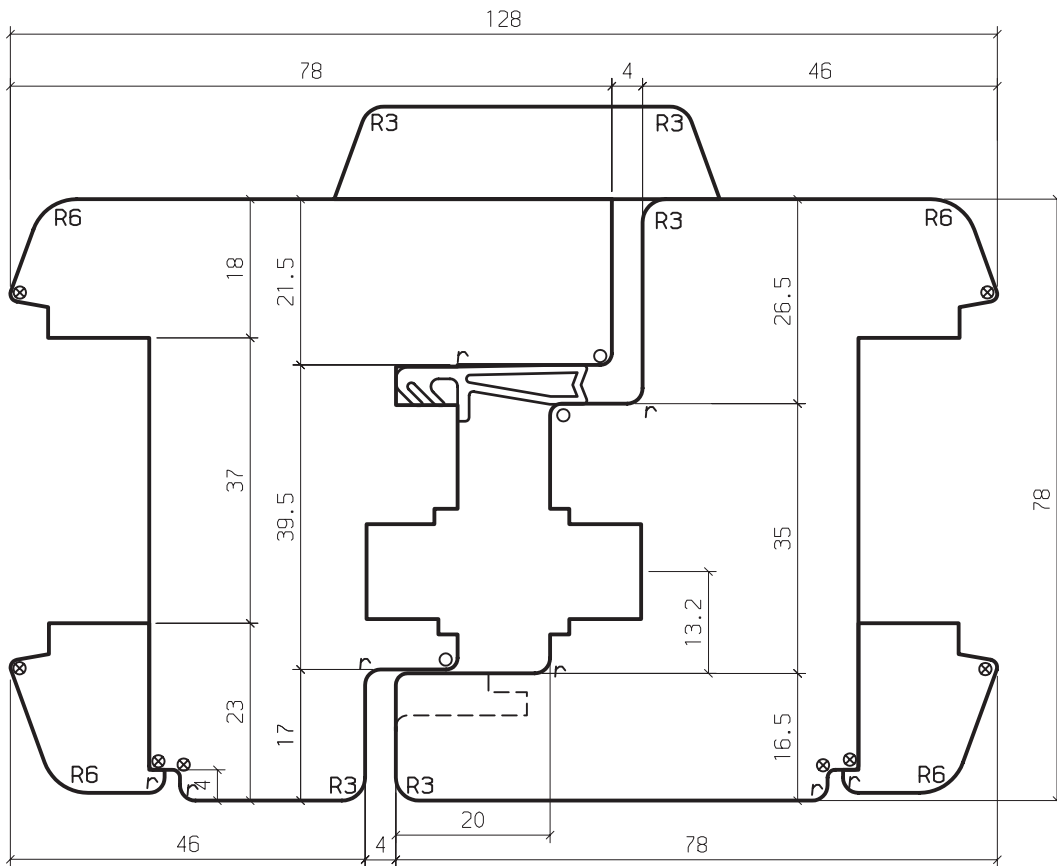

zusätzliche Optionen

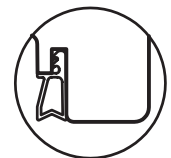

mittlere
Überschlagdichtung

Ers. durch:	(B)	Ers. für:	(A)	Maßstab	Gez.	05.11.09	DI
Aenderungen:	(C)	(D)	(E)	1:1	Gepr.	.	.
				%			
 IV FENSTER 68 MITTELPARTIE RAHMENDICHTUNG AUFGESETZTE SCHLAGEIESTE				K-Name: ALBRECHT K-Nr.: . . .			
CAD				4 09 262 031 A			

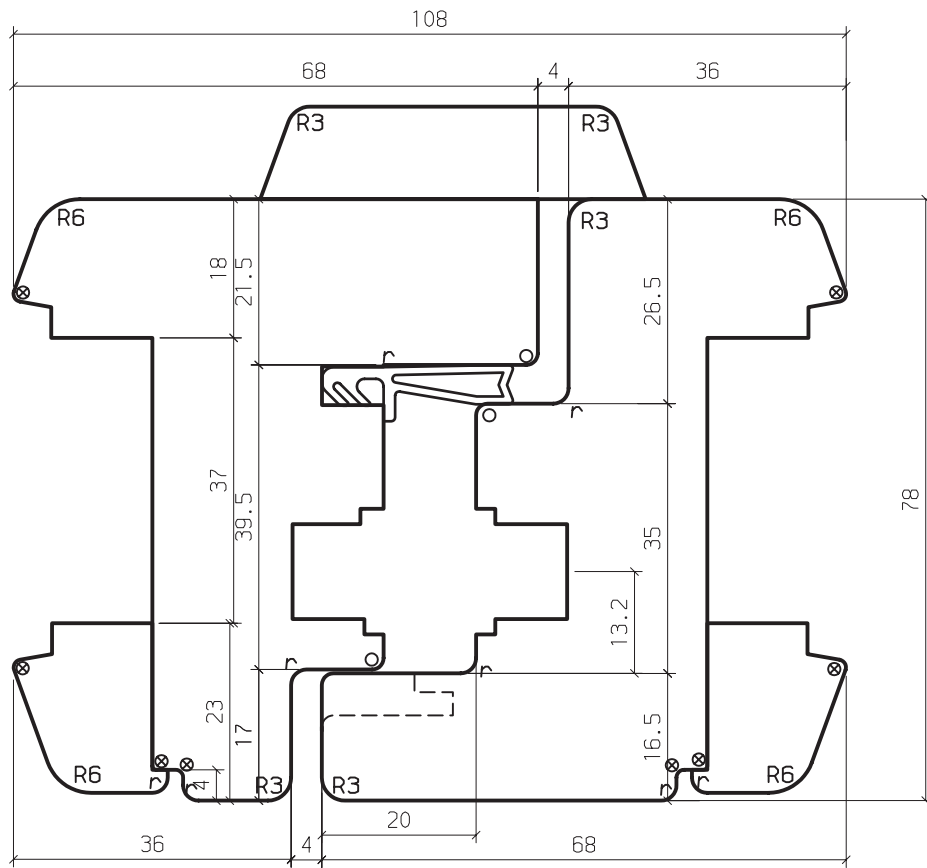

zusätzliche Optionen

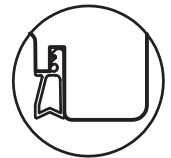

mittlere
Überschlagdichtung

Ers. durch:	(B)	Ers. für:	(A)	Maßstab	Gez.	05.11.09	DI
Aenderungen:	(C)	(D)	(E)		1:1	Gepr.	.
	(F)	(G)			γ		.
IV FENSTER 68 MITTELPARTIE RAHMENDICHTUNG AUFGESETZTE SCHLAGEIESTE				K-Name: ALBRECHT K-Nr.: .			
				4 09 262 032 A			

CAD

- ☒ = Schleifzugabe
- * = 0.5 mm
- = 0.5x45°
- X = 1 x45°
- = 1.5x45°
- ▽ = 2 x45°
- = R 0.5
- ⊗ = R 1
- = R 1.5
- = R 2
- R = R 2.5

zusätzliche Optionen

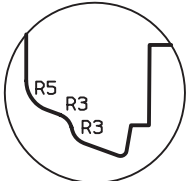

Rustikal Profil
am Flügel

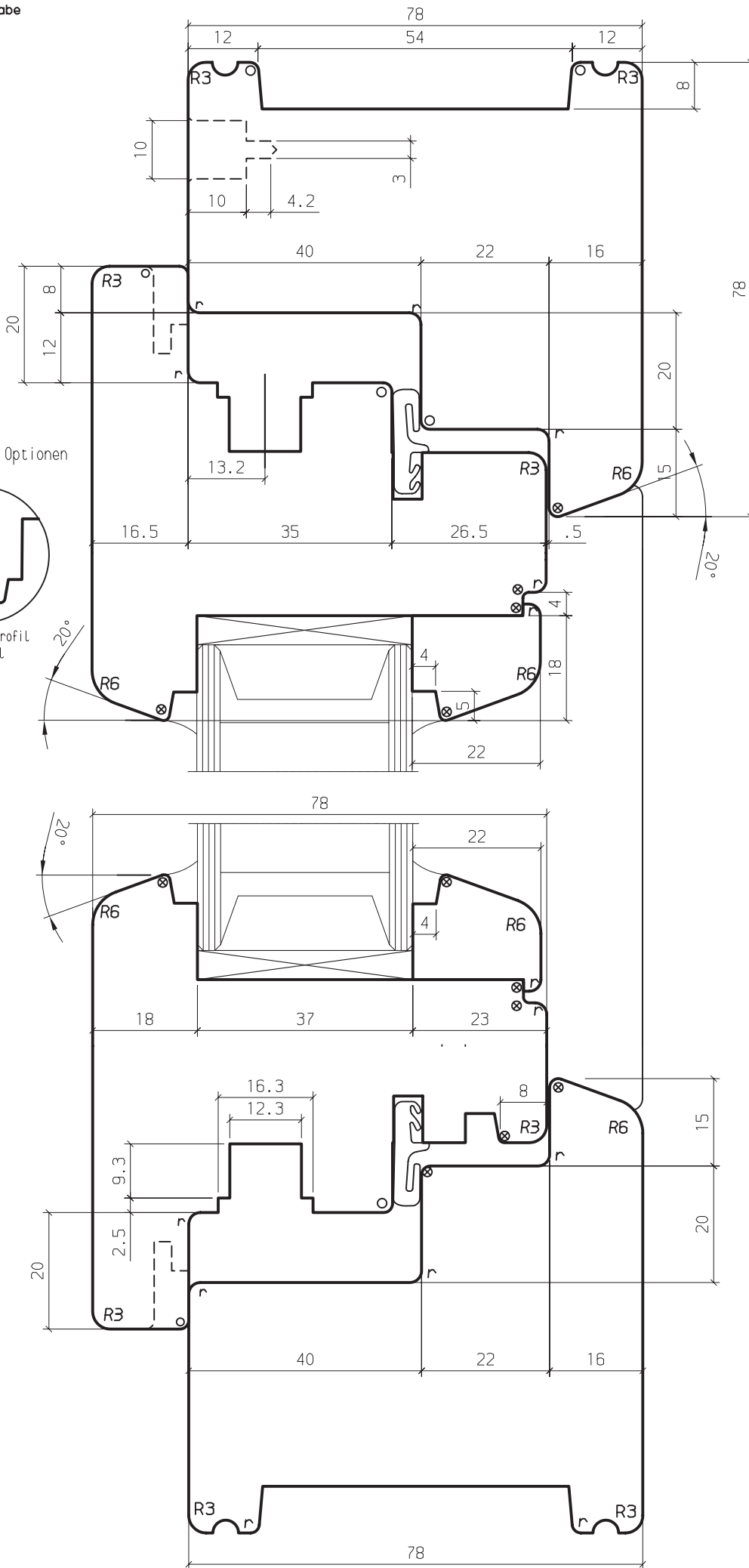

Maßstab	Gez.	05.11.09	DI
	1:1		
	Gepr.		
	✓		
K-Name: ALBRECHT			
K-Nr.: . . .			
IV FENSTER 78			
NACH AUSSEN ÖFFNEND			

CAD

4 09 262 033 A